

Carbon Dynamic Airbox

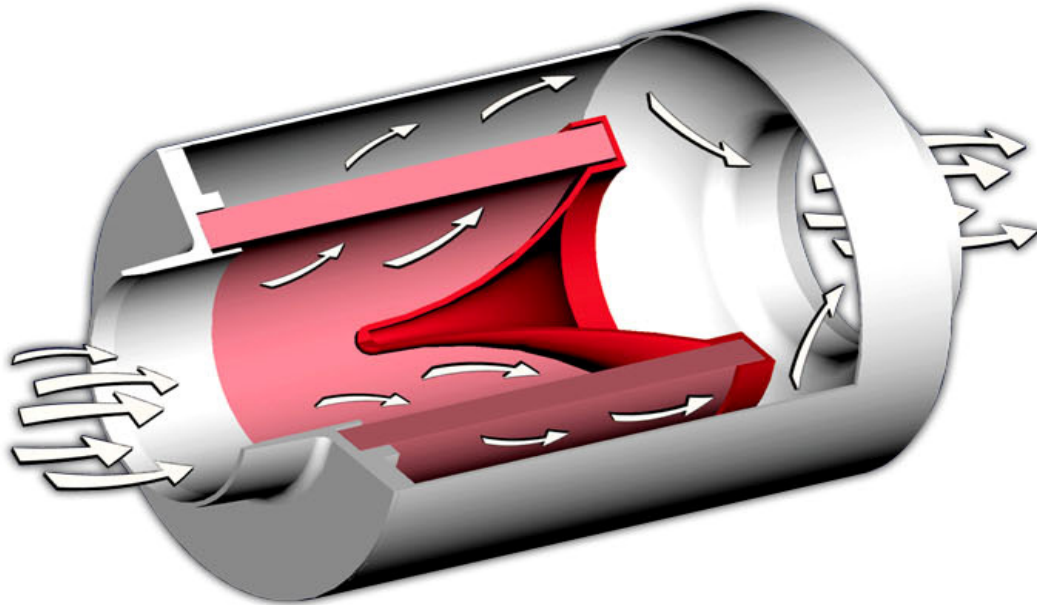

***Patented
Supercharging System***

Carbon Dynamic Airbox

De Carbon Dynamic Airbox van BMC is een compleet air intake systeem. Door de dynamic air intake creëert u een echte supercharging systeem (RAM-Air effect) dat koude lucht met een veel hogere snelheid en capaciteit naar de motor toevoert dan traditionele systemen.

De airflow die de Carbon Dynamic Airbox binnen gaat wordt verder versnelt door de conische flow variator binnenin de Carbon Dynamic Airbox. Uiteindelijk zal een aanzienlijke verhoging van het motorvermogen en trekkracht verzekerd zijn door elementen als dynamic overboosting, grotere airflow, hogere druk en koelere lucht. Daarom presteert deze technologie optimaal zowel naast als op het circuit.



Er is voor een standaard uitgevoerde auto veel vermogenswinst realiseerbaar, wij weten dat er over het algemeen een vermogenswinst realiseerbaar is van gemiddeld 5%. In de praktijk is dit ongeveer tussen de 2 en 25 pk (auto afhankelijk en getest op een geremde rollenbank). Wanneer u het management aanpast en/of een ander uitlaatsysteem plaatst, wordt het effect in combinatie met de Carbon Dynamic Airbox nog groter. De Carbon Dynamic Airbox zorgt niet alleen voor extra vermogen en koppel maar ook voor een directer gasrespons en een soepeler verloop. Bij een zelfde rijstijl als voorheen is het zelfs zo dat de auto zuiniger wordt... Dit is mede te danken aan een betere lucht/mengsel verhouding, vullingsgraad en dus een betere verbranding. Het resultaat is meer vermogen over het gehele gebied, waardoor het gaspedaal minder diep ingetrapt hoeft te worden om hetzelfde vermogen te krijgen en er dus een klein beetje minder brandstof wordt ingespoten.

Omdat het aanzuigpunt van de filter laag zit door de air intake slang hoort u in de auto iets minder van het aanzuigen als dat van een normale openluchtfILTER. Echter is het buiten de auto ronduit spectaculair! Maar deze filters zijn niet ontworpen om geluid te produceren maar om echte vermogenswinst te creëren. Dit zelfde systeem gebruikt BMC o.a. ook in de Formule-1 en de 24h races (5 bekende Formule-1 teams met o.a. het Ferrari team racen ook met BMC). Met een BMC Carbon Dynamic Airbox hebt u alvast één ding gemeen met 's werelds beste coureurs...



Zoals de naam al doet vermoeden is de Carbon Dynamic Airbox rijkelijk uitgerust in 100% gevlochten Carbon. Dit geeft de airbox niet alleen een exotisch uiterlijk maar heeft ook als voordeel dat deze airbox ultralicht is en de motorwarmte buiten de box houdt (Carbon is namelijk een perfecte isolator).

U kunt een Carbon Dynamic Airbox met geen enkel ander luchtsysteem vergelijken, het is een uniek systeem waar patent op zit. Met een CDA box hebt u iets unieks en sensationeels in uw auto zitten en het zal uw wensen doen overtreffen.

BMC... 's Werelds beste luchtfILTER merk!

Carbon Dynamic Airbox



Speciale CDA (Carbon Dynamic Airbox) Kits

| Bestelnr | Aansluitdiam. | Buitendiam. | Lengte |
|-----------|---------------|-------------|--------|
| CDA SP-01 | 80 | 150 | 200 |
| CDA SP-02 | 80 | 150 | 260 |
| CDA SP-03 | 92 | 150 | 260 |
| CDA SP-04 | 100 | 150 | 470 |
| CDA SP-11 | 81 | 150 | 200 |

De CDA SP-11 is speciaal ontwikkeld voor de Nissan 350 Z

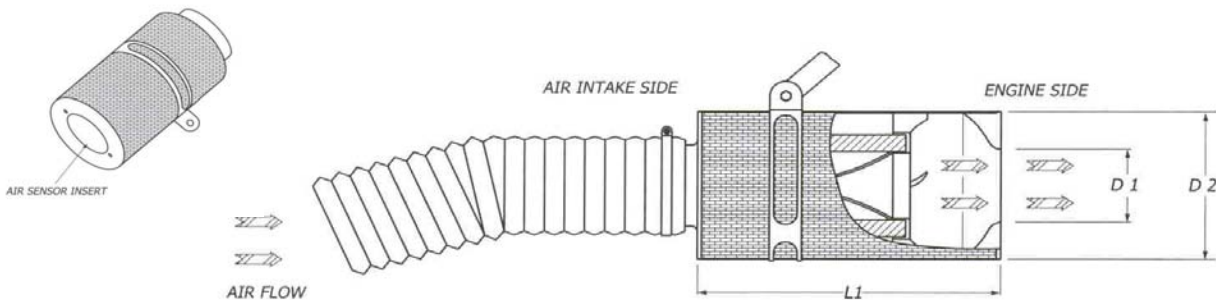

Geadviseerde applicatie voor auto's met een BOSCH luchtmassa meter met een diameter van 80mm (CDA SP-01, CDA SP-02) en een diameter van 90 mm (CDA SP-03). De luchtmassa meter moet direct gemonteerd worden op de motor zijde van de CDA.

Speciale CDA (Carbon Dynamic Airbox) Kits

| Bestelnr | Aansluitdiam. | Buitendiam. | Lengte |
|-----------|---------------|-------------|--------|
| CDA SP-06 | 100 | 186 | 236 |
| CDA SP-07 | 85 | 150 | 160 |
| CDA SP-08 | 70 | 150 | 160 |
| CDA SP-10 | 70 | 150 | 200 |

De CDA SP-06 is speciaal ontwikkeld voor de BMW M3 E46

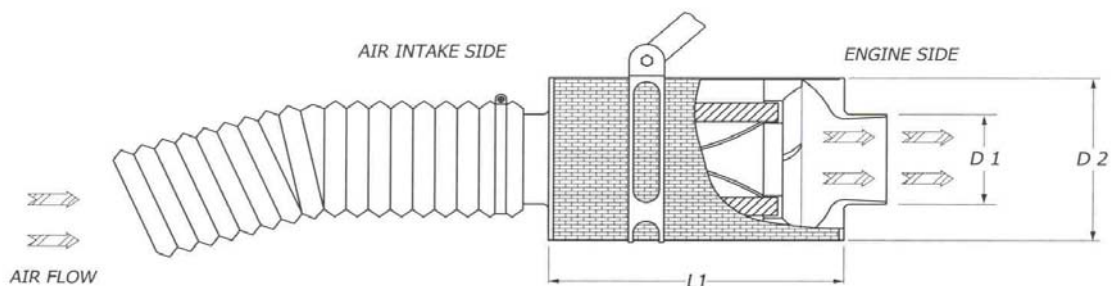

Carbon Dynamic Airbox

Speciale CDA (Carbon Dynamic Airbox) Kits

| Bestelnr | Aansluitdiam. | Buitendiam. | Lengte |
|-----------|---------------|-------------|--------|
| CDA SP-05 | 70 | 150 | 200 |
| CDA SP-09 | 80 | 150 | 200 |
| CDA SP-12 | 80 | 150 | 260 |
| CDA SP-14 | | | |

Binnenkort

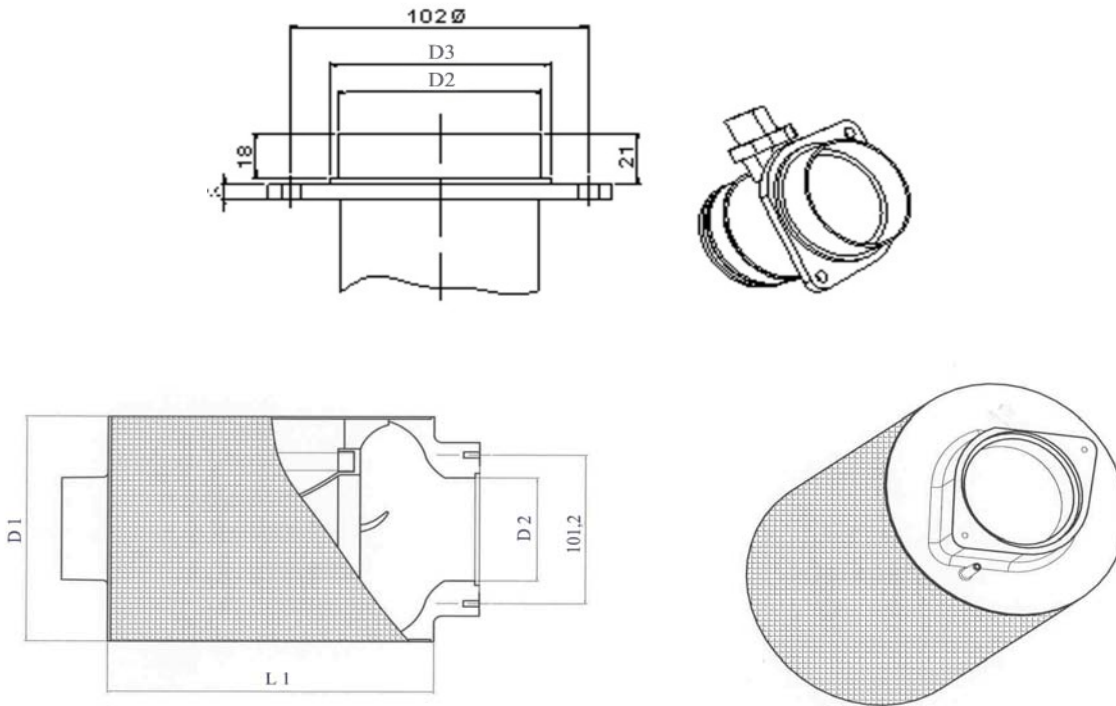

De CDA SP-05, CDA SP-09 en CDA SP-12 - Carbon Dynamic Airbox - Kan alleen geïnstalleerd worden op auto's die een originele BOSCH Luchtmassa meter >PBT-GF30< (Ø 70mm en Ø 80mm) hebben. Zie hiervoor de bovenstaande tekeningen. Dankzij een speciale adapter op de CDA is het mogelijk om de de Luchtmassa meter direct op de filter te monteren. Dit garandeert een zeer gemakkelijke aansluiting tussen de twee componenten, reduceert een zeer groot gedeelte van de in te nemen ruimte en zorgt ervoor dat er een betere lucht doorvoer mogelijk is.

CDA (Carbon Dynamic Airbox) - Universeel

| Bestelnr | Aansluitdiam. | Buitendiam. | Lengte |
|--------------------------------|---------------|-------------|--------|
| CDA 60-130 (>> - 1600cc) | 60 | 130 | 185 |
| CDA 65-130 (>> - 1600cc) | 65 | 130 | 185 |
| CDA 70-130 (>> - 1600cc) | 70 | 130 | 185 |
| CDA 70-130WC (o.a. watersport) | 70 | 130 | 130 |
| CDA 70-150 (1600cc - >>) | 70 | 150 | 200 |
| CDA 85-150 (1600cc - >>) | 85 | 150 | 200 |

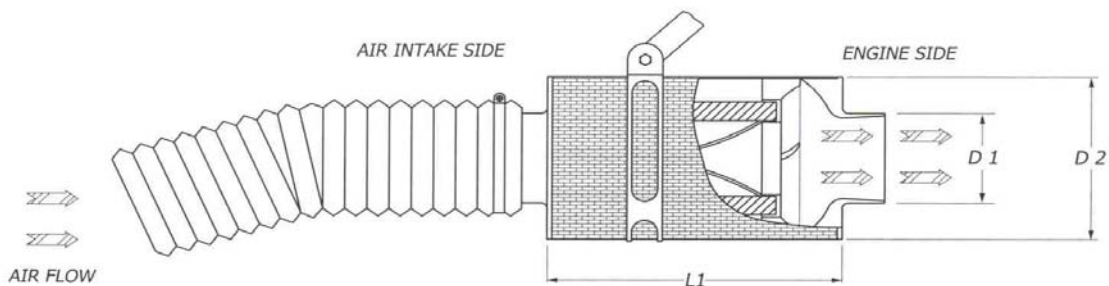

Carbon Dynamic Airbox Applicaties

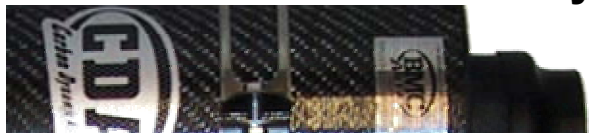

Andere modellen op aanvraag



| | Foto | CDA | ACCESSOIRES (Niet Inbegrepen) |
|--|------|-----|-------------------------------|
|--|------|-----|-------------------------------|

Alfa Romeo

| | | | | |
|------------|------------------|----|------------|---------------------------------|
| 145 | 1.3 Boxer | 1A | CDA 70-130 | |
| | 1.6 TS 16V | 1B | CDA 70-130 | |
| 147 | 1.6 TS 16V | 1E | CDA 70-130 | |
| | 1.9 JTD | | CDA 70-130 | SAC 09070 |
| | 2.0 TS 16V | 1F | CDA 70-150 | SATR 60070 |
| | 2.0 TS Selespeed | 1H | CDA 70-150 | |
| | 3.2 V6 GTA | 1G | CDA SP-01 | Flens aanpassen tot 87mm |
| 155 | | | CDA 70-130 | |
| 156 | 1.6 TS 16V | 1D | CDA 70-150 | SAM 08070, SAC 09070, SPV 10070 |
| | 1.8 TS 16V | 1D | CDA 70-150 | SAM 08070, SAC 09070, SPV 10070 |
| | 1.9 JTD | 1C | CDA 70-150 | SAM 08070 |
| | 2.0 TS 16V | | CDA 70-150 | SAM 08070 |
| | 2.4 JTD | | CDA 70-150 | SAM 08070, SAC 09070, SPV 10070 |
| | 3.2 V6 GTA | | CDA SP-01 | Flens aanpassen tot 87mm |
| 166 | 2.0 TS 16V | | CDA 85-150 | |
| | 2.4 JTD | | CDA 70-150 | SAM 08070, SAC 09070 |
| GTV | 3.0 24V | | CDA 70-150 | SAC 09070 |

Audi

| | | | | |
|----------------|---------------------|-------------------|------------|---|
| 80 / 90 | 2.8 V6 | | CDA 85-150 | |
| S2 | 2.2 Turbo | | CDA SP-01 | |
| A3 | 1.8 | | CDA 70-150 | SAM 08070, SA 16-40 |
| | 1.8 Turbo | 2A | CDA 70-150 | SAM 08070, SA 16-40 |
| | 1.9 TDI 90pk | 2B | CDA 70-150 | SAM 08070, SA 16-40 |
| | 1.9 TDI 110pk | | CDA 70-150 | SAM 08070, SA 16-40 |
| | 1.9 TDI 130pk | | CDA 85-150 | SAM 08085 |
| | 2.0 TDI 140pk | 2I | CDA SP-09 | SPV 10080, SAM 08085 |
| | S3 | 1.8 Turbo Quattro | 2C | CDA SP-02 |
| A4 | 1.8 | | CDA SP-01 | |
| | 1.8 Turbo | | CDA SP-01 | |
| | 1.9 TDI | | CDA SP-05 | |
| | 2.5 TDI V6 | | CDA SP-01 | |
| | 2.5 TDI V6 Serie 2 | 2H | CDA 85-150 | SAM 08085 |
| | 3.0 V6 Serie 2 | | CDA 85-150 | Flens aanpassen tot 80mm |
| S4 | 2.2 Turbo 20V | | CDA 85-150 | |
| | 2.7 Biturbo | | CDA SP-02 | |
| RS4 | 2.7 BiTurbo | 2D | CDA SP-03 | excl. adaptor voor originele lucht inlaat |
| A6 | 2.5 TDI V6 | 2E | CDA SP-01 | excl. adaptor voor originele lucht inlaat |
| TT | 1.8 T 180pk | 2G | CDA SP-05 | |
| | 1.8 T Quattro 225pk | 2F | CDA SP-12 | |
| | 3.2 250pk | | CDA SP-12 | |

BMW

| | | | | |
|----------------|----------------------|----|------------|---------------------|
| 3 Serie | 316 i (E36) | | CDA SP-05 | |
| | 318 is (E30) | | CDA 65-130 | |
| | 318 is (E36) | | CDA 70-150 | |
| | 318 Ci (E46) | | CDA 70-150 | SAM 08070 |
| | 320 i (E36) | | CDA 70-150 | SAM 08070, SA 16-40 |
| | 320 i (E46) | 3I | CDA 85-150 | SAM 08085 |
| | 323 Ci (E46) | | CDA 85-150 | SAM 08085 |
| | 325 i (E30) | | CDA 85-150 | Flens aanpassen |
| | 325 TI Compact (E46) | | CDA 85-150 | SAM 08085 |
| | 328 i (E36) | 3M | CDA 85-150 | SAM 08085 |

Carbon Dynamic Airbox Applicaties

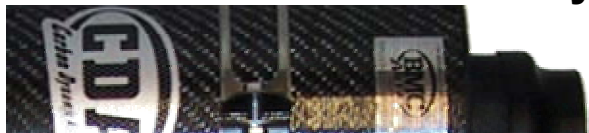

Andere modellen op aanvraag



| | | Foto | CDA | ACCESSOIRES (Niet Inbegrepen) |
|--|--|------|-----|-------------------------------|
|--|--|------|-----|-------------------------------|

| | | | | |
|--|--|--|--|--|
| | | | | |
| | | | | |

BMW Vervolg

| | | | | |
|----------------|-----------------|----|----------------|------------------------------------|
| 3 Serie | 328 i (E46) | 3B | CDA 85-150 | SAM 08085 |
| | 330 Ci (E46) | 3P | CDA 85-150 | SAM 08085 |
| | M3 4 Cil. (E30) | | CDA 85-150 | Flens aanpassen |
| | M3 3.0 (E36) | 3A | CDA 85-150 | SA 20-40, flens aanpassen tot 80mm |
| | M3 3.2 (E36) | 3H | CDA 85-150 | SA 20-40, SAM 08085 |
| | M3 3.2 (E46) | 3O | CDA SP-06 | |
| 5 Serie | 528 (E39) | | CDA 85-150 | SAM 08085 |
| | M5 5.0 i (E39) | 3C | 2 x CDA 85-150 | |
| 7 Serie | 750 il | 3Q | 2 x CDA 70-150 | 2 x SAM 08070 |
| X-5 | 3.0 i | 3G | CDA SP-01 | |
| Z1 | Alle modellen | 3D | CDA 70-150 | SAD 708233, SAM 08070 |
| Z3 | 1.8 i | 3E | CDA 70-130 | SAM 08070, SA 16-40 |
| | 1.9 i | | CDA 70-150 | SAC 09070 |
| | 2.8 i | 3N | CDA SP-07 | SAM 08085 |
| | 3.0 i | 3F | CDA SP-07 | SAM 08085 |
| | 3.0 i | 3L | CDA SP-02 | |

Chrysler

| | | | | |
|-------------------|---------|-----|------------|--|
| PT Cruiser | 2.0 16V | 23A | CDA 60-130 | |
| | 2.2 CRD | 23B | CDA SP-05 | |

Citroën

| | | | | |
|----------------------|--------------|----|------------|---------------------------------|
| C3 | 1.6 16V | 4E | CDA 70-130 | SAC 09070, SA 12-40 |
| Saxo | 1.4 8V | | CDA 70-130 | SAC 09070 |
| | 1.6 VTS 8V | 4A | CDA 70-130 | 2 x SA 20-40 |
| | 1.6 VTS 16V | 4B | CDA 70-130 | SA 12-40 |
| Xsara | 1.4 VTR | 4D | CDA 70-130 | SATR 60070 |
| | 1.9 D | | CDA 70-150 | SATR 60070 |
| | 2.0 16V | | CDA 70-150 | SATR 60070 |
| | 2.0 HDI 90pk | | CDA 70-150 | SAM 08070, SAC 09070, SPV 10070 |
| Xsara Picasso | 1.8 16V | 4C | CDA 65-130 | |

Ferrari

| | | | | |
|-------------------|--|----|----------------|---|
| 348 | | 5A | 2 x CDA 85-150 | |
| 355 | | 5B | 2 x CDA 85-150 | |
| 360 Modena | | 5C | 2 x CDA 85-150 | excl. adaptor voor originele lucht inlaat |

Fiat

| | | | | |
|-----------------------|------------------|----|------------|--|
| Barchetta | 1.8 16V | 6G | CDA 70-150 | |
| Bravo | 1.6 16V | 6H | CDA 70-130 | SAM 08070 |
| | 1.8 16V | | CDA 70-150 | SATR 60070 |
| | 2.0 20V HGT | 6F | CDA 70-150 | SATR 60070 |
| Coupé | 2.0 20V | 6L | CDA 70-150 | SATR 60070 |
| Punto | 1.2 8V | 6B | CDA 70-130 | SAC 09070, SARI 001 |
| | 1.2 16V Sporting | 6C | CDA 60-130 | SAM 08060 |
| | 1.4 GT | 6D | CDA 70-130 | SAC 09070, SPV 10070, SAM 08070 |
| | 1.8 16V HGT | 6E | CDA 70-150 | SAC 09070 |
| | 1.9 JTD | 6M | CDA 70-150 | SAC 09070 |
| Seicento (600) | 1.1 Sporting | 6A | CDA 70-130 | SA 16-40, excl. adaptor voor mono inj. |
| Stilo | 1.6 16V | | CDA 70-150 | |

Carbon Dynamic Airbox Applicaties

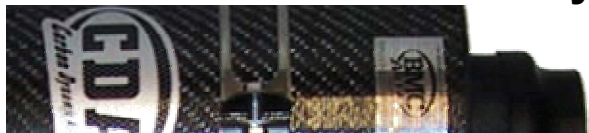

Andere modellen op aanvraag



| | | Foto | CDA | ACCESSOIRES (Niet Inbegrepen) |
|--|----------------|------|-----------|-------------------------------|
| | 2.4 20V Abarth | 6I | CDA SP-05 | |

| Ford | | | | |
|-------------|---------------------|-----|------------|------------------------------------|
| Escort | Cosworth 2.0 16V T | 27C | CDA 70-150 | 2x SA 12-40, excl. flexibele slang |
| Fiesta | 1.4 16V (Serie III) | 27D | CDA 70-150 | |
| | Zetec SE | | CDA 70-130 | SAC 09070 |
| Focus | 1.8 16V | 27B | CDA 70-150 | |
| Ka | 1.3 | | CDA 70-130 | |
| Mondeo | 2.0 TdCi 115pk | | CDA 70-150 | |
| | 2.0 TdCi 130pk | | CDA 70-150 | |
| Probe | 2.5 | 27A | CDA 85-150 | |
| Puma | 1.4 16V | | CDA 70-130 | SAC 09070 |

| Honda | | | | |
|--------------|-----------------|----|------------|--|
| Civic | 1.4 | 7A | CDA 70-130 | |
| | 1.5 8V '97> | 7G | CDA 70-130 | |
| | 1.6 VTEC | 7B | CDA 70-130 | |
| | 1.7 CTDI | 7H | CDA SP-08 | |
| | 2.0 VTEC Type-R | 7F | CDA 85-150 | |
| Integra | Type R | 7C | CDA 85-150 | |
| Prelude | 2.0 16V | | CDA 85-150 | |
| | 2.2 VTEC 4WS | 7D | CDA 70-150 | |
| S2000 | 2.0 | 7E | CDA SP-04 | |

| Hyundai | | | | |
|----------------|---------|-----|------------|--|
| Coupé | 1.6 16V | 29A | CDA 70-150 | |
| | 2.7 V6 | | CDA 85-150 | |

| Jaguar | | | | |
|---------------|-----|-----|------------|-----------|
| XJR | 4.0 | 26A | CDA 85-150 | SAM 08085 |

| Jeep | | | | |
|----------------|---------|-----|------------|-----------|
| Grand Cherokee | 2.7 CRD | 25A | CDA 85-150 | SAM 08085 |

| Lamborghini | | | | |
|--------------------|-----------|-----|----------------|-------------------------|
| Countach | 4 kleppen | 28A | 2 x CDA 85-150 | Excl. flexibele slangen |
| Diablo | 2 WD | 28B | 2 x CDA 85-150 | Excl. flexibele slangen |

| Lancia | | | | |
|---------------|----------------|----|------------|---------------------|
| Delta | 1.6 16v HPE | 8C | CDA 70-130 | |
| Thema | Turbo i.e. 16V | 8B | CDA 85-150 | Flens aanpassen |
| Ypsilon | 1.2 16V | 8A | CDA 70-130 | SAM 08070, SA 16-40 |

| Land Rover | | | | |
|-------------------|--------|--|------------|--|
| Discovery | 2.5 TD | | CDA 70-150 | |

| Lotus | | | | |
|--------------|-----|----|------------|--|
| Elise | 1.8 | 9A | CDA 70-150 | |

| Mazda | | | | |
|--------------|-----|--|------------|--|
| MX-6 | 2.5 | | CDA 85-150 | |

Carbon Dynamic Airbox Applicaties

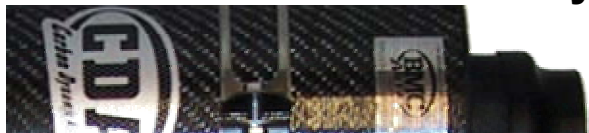

Andere modellen op aanvraag



| Foto | CDA | ACCESSOIRES (Niet Inbegrepen) |
|------|-----|-------------------------------|
|------|-----|-------------------------------|

Mercedes

| | | | | |
|-------------------|-----------------|-----|----------------|-----------|
| A-Klasse | 140 | 10A | CDA 70-130 | |
| CL-Klasse | CL 55 AMG | 10B | 2 x CDA 85-150 | |
| E-Klasse | 200 | | CDA 70-150 | |
| | 300 D | | CDA 70-150 | |
| M-Klasse | ML 270 CDI | 10C | CDA 85-150 | |
| | ML 320 (V6) | | CDA 85-150 | |
| | ML 400 CDI (V8) | 10E | CDA 85-150 | SAM 08085 |
| SLK-Klasse | 230 Kompressor | | CDA 70-150 | |
| | 260 | | CDA 70-150 | |
| | 320 | | CDA 70-150 | |
| V-Klasse | 220 CDI | 10D | CDA 70-150 | SAC 09070 |
| Vito | 112 CDI | 10F | CDA 70-150 | |

MG

| | | | | |
|-----------|-----|-----|------------|---|
| ZR | 105 | 32A | CDA 60-130 | |
| | 160 | 32B | CDA 70-150 | SAC 09070 |
| ZS | 180 | 32C | CDA 70-150 | SAC09070, SPV10070 (verkorten tot 30mm) |

Mini

| | | | | |
|-------------|----------|-----|------------|--|
| Mini | 1.6 One | 22A | CDA 70-130 | |
| | Cooper S | 22B | CDA SP-10 | |

Mitsubishi

| | | | | |
|---------------|-------------|-----|------------|-------------------------|
| Galant | 2.5 V6 EA5 | | CDA 85-150 | Past met speciale flens |
| L 200 | 2.5 TDI GLS | 11B | CDA 70-150 | |
| Lancer | 2.0 EVO VI | 11A | CDA 85-150 | Flens aanpassen |

Nissan

| | | | | |
|---------------|---------|-----|------------|--------------------------|
| 100 NX | 2.0 16V | | CDA 85-150 | Flens aanpassen |
| 200 SX | 1.8 | | CDA 85-150 | Flens aanpassen |
| 350 Z | 3.5 V6 | 12B | CDA SP-11 | |
| Almera | 2.2 DTI | 12A | CDA 85-150 | Flens aanpassen tot 80mm |
| Patrol | GR 4.2 | | CDA 85-150 | SATR 60082 |

Opel

| | | | | |
|------------------|---------------|-----|------------|-----------------|
| Astra | 1.4 | | CDA 60-130 | |
| | 1.6 16V | | CDA 70-150 | |
| | 2.0 Dti | 13B | CDA 70-150 | SAC 09070 |
| | 2.0 16V Turbo | 13E | CDA 70-150 | |
| | 2.0 16V OPC | 13F | CDA 70-150 | SAC 09070 |
| | 2.2 16V | 13N | CDA 85-150 | |
| Calibra | 2.0 8V | | CDA 85-150 | Flens aanpassen |
| Corsa | 1.0 12V | 13M | CDA 60-130 | |
| | 1.2 8V | | CDA 60-130 | SATR 60060 |
| | 1.4 | | CDA 60-130 | |
| | 1.6 16V | | CDA 60-130 | |
| | 1.7 Dti | 13I | CDA 70-130 | SAM 08070 |
| | 1.6 GSI 16V | | CDA 85-150 | SAM 08085 |
| | 1.8 GSI 16V | | CDA 70-150 | SATR 60070 |
| Omega | 2.5 TD | 13L | CDA SP-07 | |
| Speedster | 2.2 16V | 13H | CDA 70-150 | SAM 08070 |

Carbon Dynamic Airbox Applicaties

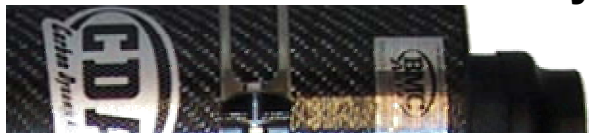

Andere modellen op aanvraag



| | | Foto | CDA | ACCESSOIRES (Niet Inbegrepen) |
|--|--|------|-----|-------------------------------|
|--|--|------|-----|-------------------------------|

| | | | | |
|---------------------|-------------|-----|------------|-----------|
| Tigra | 1.4 | 13A | CDA 60-130 | |
| Opel Vervolg | | | | |
| Tigra | 1.6 16V | 13A | CDA 60-130 | |
| Vectra | 1.8 CDX | 13D | CDA 70-150 | |
| | 2.0 CDI | | CDA 70-150 | |
| | 2.0 DTI 16V | 13C | CDA 70-150 | |
| Zafira | 1.8 16V | 13G | CDA 70-150 | SAC 09070 |
| | 2.2 DTI | | CDA 70-150 | SARI 002 |

Peugeot

| | | | | |
|------------------------|-------------------|-----|------------|--------------------------|
| 106 | 1.4 Sport | 14A | CDA 60-130 | SATR 60060, SA 12-40 |
| | GTI 16V | 14B | CDA 70-130 | |
| | 1.6 XS 16V | 14C | CDA 70-130 | SA 12-40 |
| | Rally 8V | 14L | CDA 60-130 | |
| 205 | GTI 1.6 | 14M | CDA 70-130 | |
| | GTI 1.9 | | CDA 70-130 | |
| 206 | 1.4 | | CDA 60-130 | SATR 60070, SA 16-40 |
| | 1.6 | | CDA 70-150 | SATR 60070, 2 x SA 20-40 |
| | 1.6 XS 16V | 14D | CDA 70-150 | SATR 60070 |
| | 1.6 XS 16V 110pk | | CDA 70-130 | SAC 09070, SPV 10070 |
| | 2.0 Hdi | | CDA 70-150 | SAM 08070 |
| | 2.0 16V | | CDA 70-150 | SATR 60070 |
| | 2.0 16V RC | 14O | CDA 70-130 | SAC 09070 |
| | 2.0 GTi | 14E | CDA 70-150 | SAC 09070 |
| 306 | 1.6 | | CDA 70-150 | SATR 60070, 2 x SA 20-40 |
| | 1.8 16V | | CDA 70-150 | |
| | 2.0 HDi | | CDA 70-130 | |
| 307 | 1.6 16V | 14H | CDA 65-130 | SARI 001 |
| | 2.0 16V | | CDA 70-150 | |
| | 2.0 HDI 90pk | 14G | CDA 70-150 | SAC 09070 |
| | 2.0 HDI 110pk | | CDA 70-150 | SAC 09070 |
| | 2.0 HDI 16V 136pk | | CDA 70-150 | SAC 09070 |
| 309 | 2.0 GTI 16V | | CDA 70-130 | |
| 405 | 1.9 16V | | CDA 70-150 | SAM 08070 |
| | 2.0 MI 16V | | CDA 70-150 | SATR 60070 |
| | T 16V | | CDA 70-130 | 2 x SA16-40, SA 20-40 |
| 406 / 406 Coupé | 2.0 HDI | | CDA 70-150 | SATR 60070 |
| | 2.2 HDI | 14I | CDA 85-150 | |
| | 3.0 V6 24V | 14F | CDA 85-150 | SA 12-40, SA 16-40 |

Porsche

| | | | | |
|------------|--|-----|------------------------------|----------------------|
| 944 | | 15B | CDA 85-150 met flens adaptor | |
| 993 | | | CDA 85-150 | excl. rubber adaptor |
| 996 | | 15A | CDA 85-150 | |

Renault

| | | | | |
|-----------------|--------------|-----|------------|-----------------|
| R 5 | GT Turbo | | CDA 60-130 | |
| R 19 | 1.9 TD | | CDA 70-130 | SAC 09070 |
| R 21 | 2.0 Turbo | | CDA 85-150 | |
| R 25 | 2.5 V6 Turbo | | CDA 70-130 | SA 16-40 |
| Alpine | V6 Turbo | | CDA 70-150 | SAM 08070 |
| Avantime | 3.0 V6 | | CDA 85-150 | |
| Clio | 1.4 S | 16A | CDA 60-130 | SATR 60060 |
| | 1.6 16V | | CDA 70-130 | Flens aanpassen |

Carbon Dynamic Airbox Applicaties

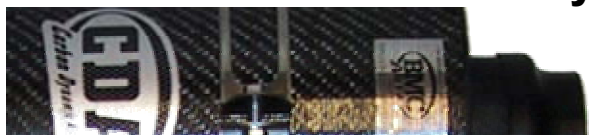

Andere modellen op aanvraag



| | | Foto | CDA | ACCESSOIRES (Niet Inbegrepen) |
|------------------------|---------------------|------|------------|--------------------------------------|
| | 1.8 16V | 16G | CDA SP-08 | SAC 09070, excl. ovale flens adaptor |
| Renault Vervolg | | | | |
| Clio | 2.0 16V 172pk | | CDA SP-08 | |
| | RS 2000 16V | 16B | CDA 70-150 | |
| | RS 2000L 16V (01->) | 16F | CDA SP-08 | |
| | Williams 2.0 | | CDA SP-07 | Speciale flens (AAPK003) |
| | 3.0 V6 24V Sport | 16L | CDA 85-150 | |
| Laguna | 1.6 16V | 16E | CDA 70-130 | |
| | 1.9 DCI 110pk | 16H | CDA 70-130 | SAM 08070, SPV 10070, SAC 09070 |
| | 1.9 DCI 120pk | 16H | CDA 70-130 | SAM 08070, SPV 10070, SAC 09070 |
| Master | 2.8 TDI | 16I | CDA 70-150 | |
| Megane | 1.6 16V | | CDA 70-130 | SAC 09070 |
| | 1.9 DTI | 16C | CDA 70-150 | SAM 08070 |
| | 2.0 16V | | CDA 70-150 | |
| | 2.0 16V IDE | | CDA 85-150 | SAM 08085 |
| | Coupé 2.0 16V | | CDA 70-150 | SAC 09070 |
| | | | | |
| Megane II | 1.6 16V | 16N | CDA 70-130 | SAC 09070 |
| Scenic | 1.6 16V | 16D | CDA 70-130 | |
| | 1.9 DTI | | CDA 70-150 | SATR 60070 |
| | RX4 DCI | 16M | CDA 70-150 | SATR 60070 |

| Rover | | | | |
|--------------|---------|-----|------------|-----------|
| 25 | 1.6 16V | | CDA 70-130 | |
| 600 | 620 TI | 17A | CDA 70-150 | SAC 09070 |

| Saab | | | | |
|-------------|------------------|-----|------------|----------------------|
| 900 | 2.0 i Turbo Aero | 30A | CDA 70-150 | SAC 09070, SPV 10070 |

| Seat | | | | |
|----------------|-----------------------|-----|------------|-----------------------|
| Arosa | 1.4 Tdi | | CDA 70-130 | SAC 09070 |
| Cordoba | 2.0 16V | | CDA 70-150 | SA 16-40 |
| Ibiza | 1.4 16V | 18A | CDA 70-130 | SAC 09070, SA 16-40 |
| | 1.4 16V 02> | 18E | CDA 70-130 | SAC 09070 |
| | 1.8 Turbo 20V | 18C | CDA 85-150 | SAM 08085 |
| | 1.8 T Cupra | | CDA SP-02 | |
| | 1.9 TDI 110pk | | CDA SP-05 | |
| | 1.9 TDI 130pk | | CDA SP-09 | |
| Leon | 1.9 TDI 110pk | 18B | CDA 70-150 | SAM 08070 |
| | 1.9 TDI Cupra 150pk | 18D | CDA 85-150 | SAM 08085 |
| | 1.8 Turbo 20V 180pk | | CDA SP-01 | |
| | 1.8 T 20V Cupra 225pk | | CDA SP-02 | |
| Toledo | TDI 110pk | | CDA 70-150 | SAD 708233, SAM 08070 |

| Smart | | | | |
|--------------|----|-----|----|----|
| | ?? | 19A | ?? | ?? |

| Subaru | | | | |
|----------------|--------------|-----|------------|---------------------------|
| Impreza | GT 211pk | 24A | CDA 85-150 | SA 12-40, Flens aanpassen |
| | GT 215pk | | CDA 85-150 | Flens aanpassen |
| | GT 215pk ABS | | CDA 85-150 | Flens aanpassen |
| | GT 217pk | | CDA 85-150 | Flens aanpassen |
| | GT 217pk ABS | 24B | CDA 85-150 | Flens aanpassen |
| | WRX 218pk | | CDA 85-150 | Flens aanpassen |

Carbon Dynamic Airbox Applicaties

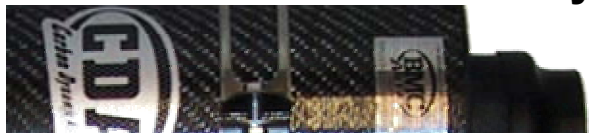

Andere modellen op aanvraag



| Foto | CDA | ACCESSOIRES (Niet Inbegrepen) |
|------|-----|-------------------------------|
|------|-----|-------------------------------|

Toyota

| | | | | |
|---------------|-----------|-----|------------|------------------------------------|
| Celica | T20 | 20A | CDA 70-150 | |
| | 1.8 VVTI | 20C | CDA 70-150 | SAC 09070 |
| Hi Lux | 2.8 | | CDA 70-150 | |
| MR2 | 1.8 VVTI | | CDA 70-150 | |
| | 2.0 | 20E | CDA 70-130 | SARI 001, Orig. buiswerk gebruiken |
| | 2.0 Turbo | 20B | CDA 70-150 | |
| Paseo | 1.5 | | CDA 60-130 | SATR 60060 |
| Picnic | 2.0 16V | | CDA 65-130 | |
| Yaris | 1.0 VVT-i | 20D | CDA 70-130 | SAC 09070, SARI 002, SATR 60060 |

Volkswagen

| | | | | |
|-----------------|---------------|-----|------------|-----------------------------------|
| Bora | 1.6 | 21I | CDA 70-150 | SAC 09070 |
| | 1.8 GTI | 21H | CDA SP-05 | |
| | TDI 90pk | 21C | CDA 70-150 | SA 16-40, SAM 08070 |
| | TDI 110pk | 21C | CDA 70-150 | SA 16-40, SAM 08070 |
| | TDI 115pk | 21E | CDA 70-150 | SAM 08070 |
| | TDI 130pk | | CDA SP-09 | |
| | TDI GTI 150pk | 21F | CDA SP-02 | SA 16-40 |
| | 2.8 I VR6 | 21G | CDA 85-150 | SAM 08085 |
| Golf II | 1.8 GTI 8V | | CDA 70-130 | SAD 708233, SAM 08070 |
| Golf III | 1.8 GTI | 21B | CDA 70-130 | SAD 708233, SAM 08070, SATR 60070 |
| | 1.8 Spi | | CDA 70-150 | SAC 09070, SATR 60082, SPV 10080 |
| | 2.8 I VR6 | | CDA 85-150 | |
| | TDI 110pk | | CDA 70-150 | SAD 708233, SAM 08070 |
| Golf IV | 1.6 | 21I | CDA 70-150 | SAC 09070 |
| | 1.8 GTI | 21H | CDA SP-05 | |
| | TDI 90pk | 21C | CDA 70-150 | SA 16-40, SAM 08070 |
| | TDI 110pk | 21C | CDA 70-150 | SA 16-40, SAM 08070 |
| | TDI 115pk | 21E | CDA 70-150 | SAM 08070 |
| | TDI 130pk | | CDA SP-09 | |
| | TDI GTI 150pk | 21F | CDA SP-02 | SA 16-40 |
| | 2.8 I VR6 | 21G | CDA 85-150 | SAM 08085 |
| | R32 | 21L | CDA SP-12 | |
| Golf V | 2.0 T FSI GTI | 21O | CDA SP-14 | Binnenkort leverbaar |
| | 2.0 TDI 140pk | 21N | CDA SP-09 | SPV 10080, SAM 08085 |
| Jetta | 1.8 GTI 8V | | CDA 70-130 | SAD 708233, SAM 08070 |
| Lupo | 1.4 | | CDA 65-130 | |
| | 1.6 GTI | 21D | CDA 70-130 | SAC 09070 |
| Passat | 2.8 I VR6 | | CDA 85-150 | |
| | TDI 90pk | | CDA SP-09 | |
| Polo | 1.1 | 21M | CDA 70-130 | SAC 09070 |
| | 1.4 | | CDA 70-130 | |
| | 1.4 16V | 21A | CDA 70-130 | SAC 09070, SA 16-40 |
| Vento | 1.8 GTI | 21B | CDA 70-130 | SAD 708233, SAM 08070, SATR 60070 |
| | 2.8 I VR6 | | CDA 85-150 | |
| | TDI 110pk | | CDA 70-150 | SAD 708233, SAM 08070 |

Volvo

| | | | | |
|-------------|-------------------|-----|-----------|--|
| 850 | 2.3i Turbo 20V T5 | | CDA SP-05 | |
| S 40 | 2.0 16V Turbo | 31A | CDA SP-01 | |
| | T4 | | CDA SP-01 | |
| V 40 | 2.0 16V Turbo | 31A | CDA SP-01 | |

Carbon Dynamic Airbox Applicaties

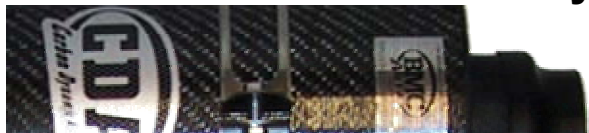

Andere modellen op aanvraag

| | | Foto | CDA | ACCESSOIRES (Niet Inbegrepen) |
|----------------------|--------------|------|-----------|-------------------------------|
| | T4 | | CDA SP-01 | |
| S 60 | 2.3 Turbo V5 | 31C | CDA SP-09 | |
| | 2.4 Turbo | | CDA SP-09 | |
| | 2.5 Turbo T5 | 31B | CDA SP-09 | |
| S 70 | 2.3 Turbo V5 | 31C | CDA SP-09 | |
| Volvo Vervolg | | | | |
| S 70 | 2.5 Turbo T5 | 31B | CDA SP-09 | |
| V 70 | 2.3 Turbo V5 | 31C | CDA SP-09 | |
| | 2.5 Turbo T5 | 31B | CDA SP-09 | |
| C 70 | 2.3 Turbo V5 | 31C | CDA SP-09 | |
| | 2.5 Turbo T5 | 31B | CDA SP-09 | |
| S 80 | 2.8 Turbo T6 | 31D | CDA SP-02 | Flens aanpassen tot 86mm |

Accessoires

Luchtfilter olie en reiniger



| Omschrijving | Inhoud | Bestelnr |
|--|--------|------------|
| Luchtfilter olie | 250ml | WA OIL250 |
| Luchtfilter olie, spray | 200ml | WA OIL200 |
| Luchtfilter reiniger | 355ml | WA DET355 |
| Luchtfilter olie en reiniger set | | WA 250/355 |
| Luchtfilter olie (spray) en reiniger set | | WA 200/355 |

CDA - interne filter element

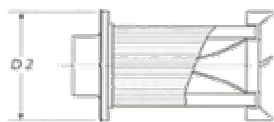
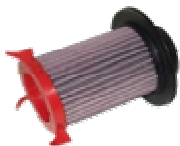

| Diameter | Bestelnr |
|----------|------------|
| 130 | CDA RI-130 |
| 150 | CDA RI-150 |

Siliconen Connector Buis (dikte 5mm)

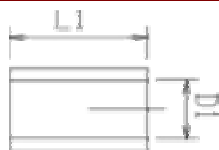

| Diameter 1 | Lengte 1 | Bestelnr |
|------------|----------|-----------|
| 60 | 80 | SAM 08060 |
| 70 | 80 | SAM 08070 |
| 85 | 80 | SAM 08085 |

EPDM Rubber Connector met een bocht van 90° (dikte 5mm)

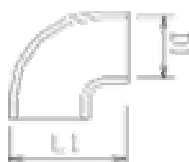

| Diameter | Lengte | Bestelnr |
|----------|--------|-----------|
| 70 | 110 | SAC 09070 |

Roestvrijstalen Klem met Rubberen Inleg

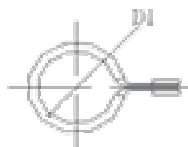

| Diameter | Bestelnr |
|----------|-----------|
| 80 | SAF 00080 |

Flexibele Aluminium Buis



| Diameter | Lengte | Bestelnr |
|----------|--------|------------|
| 60 | 500 | SAT 50060 |
| 70 | 500 | SAT 50070 |
| 80 | 500 | SAT 50080 |
| 60 | 600 | SATR 60060 |
| 70 | 600 | SATR 60070 |
| 82 | 600 | SATR 60082 |

Roodgeverfde Stalen Connector met Pin voor Ophanging (dikte 1,5mm)



| Diameter | Lengte | Bestelnr |
|----------|--------|-----------|
| 60 | 100 | SPV 10060 |
| 70 | 100 | SPV 10070 |
| 80 | 100 | SPV 10080 |

Accessoires

Nylon Adapters

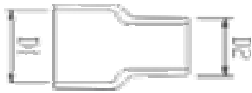

| Diameter 1 | Diameter 2 | Bestelnr |
|------------|------------|----------|
| 70 | 60 | SARI 001 |
| 70 | 65 | SARI 002 |
| 85 | 70 | SARI 003 |

Ophangbeugel



| Lengte | Bestelnr |
|--------|----------|
| 200 | SPF 200 |

Luchtmasa Sensor Connector (vierkante flens)

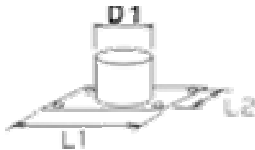

| Diameter | Lengte 1/2 | Bestelnr |
|----------|------------|------------|
| 70 | 82 / 33 | SAD 708233 |

Carter Ontluchting - Universeel



| Diameter | Lengte 1/2 | Bestelnr |
|----------|------------|----------|
| 12 | 40 | SA 12-40 |
| 16 | 40 | SA 16-40 |
| 20 | 40 | SA 20-40 |
| 25 | 40 | SA 25-40 |

Luchtfiler Display

Bestelnr

Bel voor info!



Type "Auto"



Type "Motor"